

PR-57 Series*

High Pressure Corrosion Resistant Regulator (10,000 psig Inlet)



To meet the demands for the safe reduction of inlet pressures up to 10,000 psig, Circle Seal Controls provides the PR-57 Series regulator. This precision regulator features a piston-sensing design which provides the operator with low adjusting torque requirements when setting the outlet pressure. The body is constructed from 316L stainless steel, providing the ultimate in safety and corrosion resistance.

The optional self-relieving feature provides an additional level in operational ease, as it allows for trapped downstream pressure to be safely vented to atmosphere through the bonnet.

** Replaces the LRxxE Series.*

Features & Specifications

- Gas or liquid service
- 316L stainless steel construction
- Better than 25 Ra finish in diaphragm cavity
- Stainless steel spring-loaded piston sensor
- 20 μ filter
- Bubble-tight shutoff
- Inlet pressure maximum 10,000 psig
- Outlet pressure ranges are 0–250 psig, 0–500 psig, 0–750 psig, 0–1,000 psig, 0–2,000 psig, 0–4,000 psig, 0–6,000 psig, 0–7,500 psig, and 0–10,000 psig
- Operating temperatures: –40° F to +150° F (–40° C to +66° C)
- Cv flow coefficient 0.05 or 0.2 (optional)

Applications

- Pilot plants
- Specialty gas
- Compressors
- High pressure test systems
- Breathing air tank refill

Options

- Gauges and CGA fittings for cylinder gas applications
- Self-relieving and captured vent
- 3/8" FNPT, 1/4" AND10050–4, 1/4" SAE J514, 1/4" MS33649, 1/4" Aminco, or 1/4" sch 40 pipe

Circle Seal Controls

2301 Wardlow Circle • Corona, CA 92880
 Phone (951) 270-6200 • Fax (951) 270-6201
 www.circle-seal.com

pressure regulators

PR-57 Series

How to Order

K/ PR57 - 1 A 1 1 C 2 N 1 4 1 C

REPAIR KIT ————

BODY MATERIALS ————

- 1 316L stainless steel
- 4 Monel®

PORT CONFIGURATION ————

- A Standard (one inlet & one outlet port)

For more port configurations, see page 35.

PROCESS PORT TYPES ————

- 1 ¼" FNPT (¼" FNPT gauge ports)
- 2 ¼" tube (¼" tube gauge ports)
- 4 ⅜" FNPT (¼" FNPT gauge ports)
- 7 AND10050-4 (¼" FNPT gauge ports)
- 8 SAE J514 (¼" FNPT gauge ports)
- 9 MS33649 (¼" FNPT gauge ports)
- F ¼" Aminco (¼" FNPT gauge ports)
- K ¼" sch 40 pipe (¼" FNPT gauge ports)

SURFACE FINISH/DIAPHRAGM CAVITY ————

- 1 < 25 Ra
- 5 < 25 Ra, with 10-32 mounting holes

SEAT MATERIALS ————

- C Polyimide (standard)
- Q PEEK™

FLOW COEFFICIENT ————

- 2 0.05 (standard)
- 5 0.2

CAP ASSEMBLY

- 1 Standard, aluminum
- 4 Panel mount, aluminum
- 5 Captured vent, aluminum
- 6 Captured vent, panel mount, aluminum
- 7 Captured vent, stainless steel
- F Stainless steel
- W Panel mount, stainless steel
- V Captured vent, panel mount, stainless steel

PISTON MATERIAL

- 4 Stainless steel/Teflon® cavity o-ring
- 5 Stainless steel/Viton® cavity o-ring
- 6 Monel®/Viton® cavity o-ring
- 7 Monel®/Teflon® cavity o-ring

PISTON TYPE

- 1 Non-self-relieving
- 3 Self-relieving

OUTLET RANGE

- I 0-250 psig
- J 0-500 psig
- W 0-750 psig
- K 0-1,000 psig
- L 0-2,000 psig
- N 0-4,000 psig
- O 0-6,000 psig
- P 0-7,500 psig
- Q 0-10,000 psig

Maximum Temperature & Operating Inlet Pressures

Seat Material	Maximum Temperature*	@	Maximum Operating Inlet Pressure
Polyimide	150° F (66° C)	@	10,000 psig (68.95 MPa)
PEEK™	150° F (66° C)	@	10,000 psig (68.95 MPa)

Outline & Mounting Dimensions

Weight = 4.4 lbs (2.0kg)

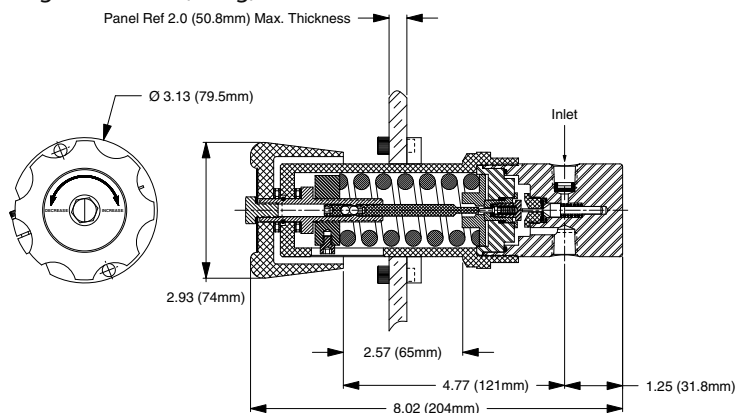

For Your Safety

It is solely the responsibility of the system designer and user to select products suitable for their specific application requirements and to ensure proper installation, operation, and maintenance of these products. Material compatibility, product ratings and application details should be considered in the selection. Improper selection or use of products described herein can cause personal injury or property damage.

Monel® is a registered trademark of Special Metals Corporation.
 PEEK™ is a trademark of Victrex PLC.
 Teflon® is a registered trademark of the DuPont Company.
 Viton® is a registered trademark of DuPont Dow Elastomers.

Porting Configurations for Pressure Regulators

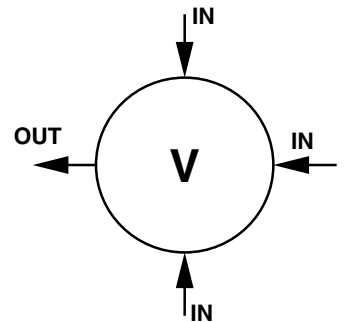
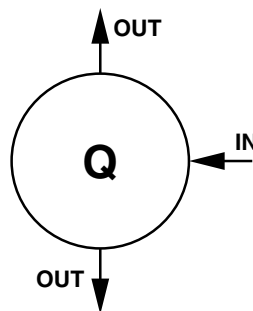
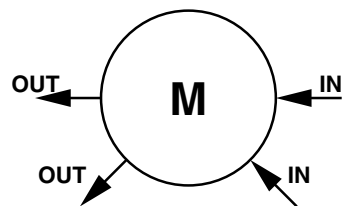
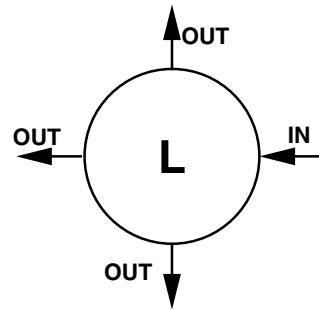
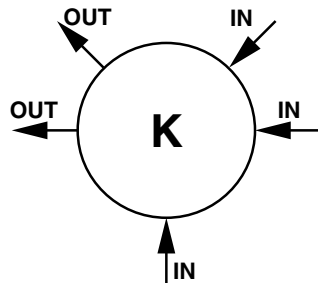
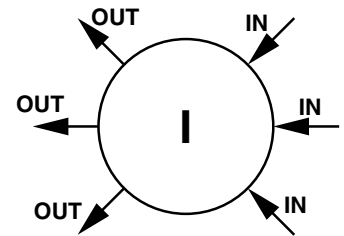
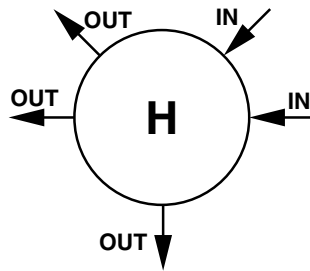
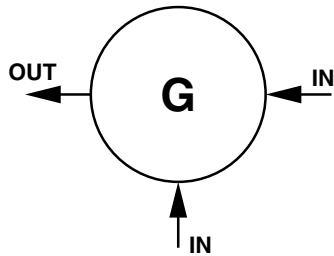
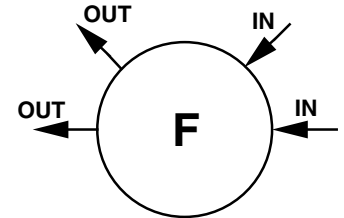
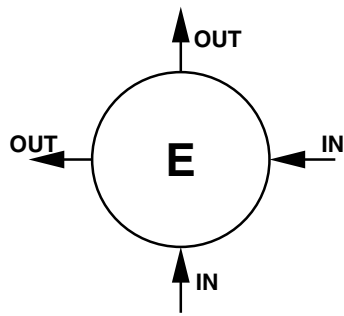
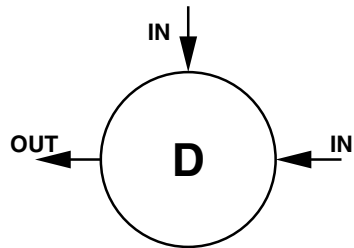
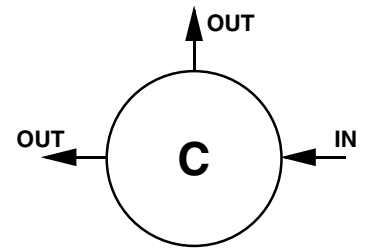
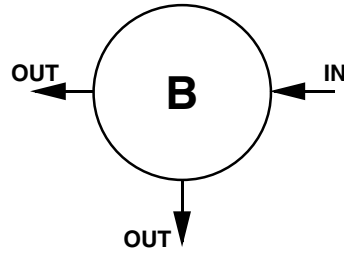
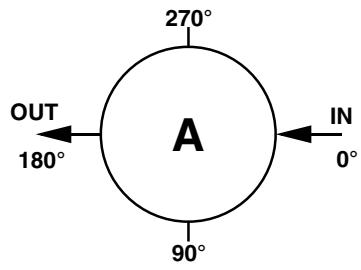

Location Of Ports From Top View